

# HS527 OTP Encoder

---

## HS527 Description: (Compatible:EV1527,RT1527,FP1527)

HS527 is OTP Encoder utilizing CMOS technology process. HS527 has a maximum of 20 bits providing up to 1 million codes. It can reduce any code collision and unauthorized code scanning possibilities.

## HS527 Features: (Compatible:EV1527,RT1527,FP1527)

CMOS Technology

Low stand by Current:1.0uA

Wide range of Operating Voltage:Vcc = 3.0~12V

Up to 4 data pins

Total 1048576 address codes

Single Resistor Oscillator

Available in DIP and SOP Package

## HS527 Pin out: (Compatible:EV1527,RT1527,FP1527)

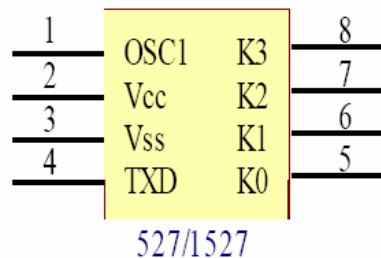

## HS527 Pin Description: (Compatible:EV1527,RT1527,FP1527)

Pin No.	Name	Description	I/O
1	OCSI	Oscillator input pull-up R to Vcc	I
2	Vcc	Positive power supply	
3	GND	Ground	
4	Dout	Data output pin	O
5	K0	Data input with pull-low R	I
6	K1	Data input with pull-low R	I
7	K2	Data input with pull-low R	I
8	K3	Data input with pull-low R	I

---

Silvan Chip Electronics Tech.Co.,Ltd.

Address: Fl.16 FuChang Building, Binhe Rd, Shenzhen, China

Phone: 86-0755-88291843 88304213 Fax : 86-0755-88290509

Email: [jj@sc-tech.cn](mailto:jj@sc-tech.cn)

Http:// [www.sc-tech.cn](http://www.sc-tech.cn)

# HS527 OTP Encoder

## HS527 Output format: (Compatible:EV1527,RT1527,FP1527)

Output data frame:

Preamble	C0 ~ C19 (1 million codes)	D0	D1	D2	D3
----------	----------------------------	----	----	----	----

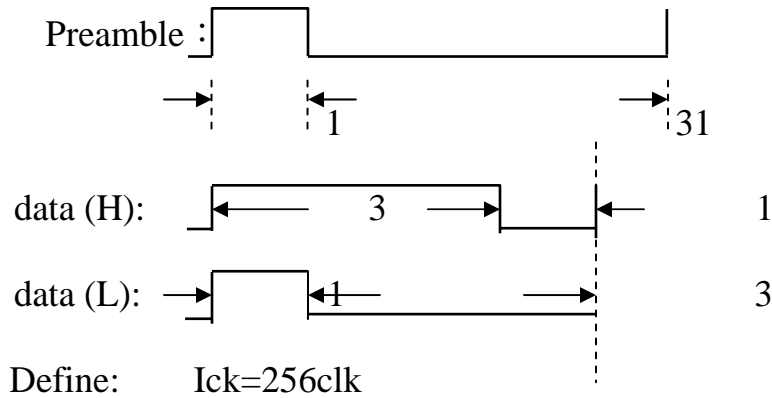

## HS527 K0~K3 combination Table: (Compatible:EV1527,RT1527,FP1527)

K3	K2	K1	K0	D3	D2	D1	D0
0	0	0	1	0	0	0	1
0	0	1	0	0	0	1	0
0	0	1	1	0	0	1	1
0	1	0	0	0	1	0	0
0	1	0	1	0	1	0	1
0	1	1	0	0	1	1	0
0	1	1	1	0	1	1	1
1	0	0	0	1	0	0	0
1	0	0	1	1	0	0	1
1	0	1	0	1	0	1	0
1	0	1	1	1	0	1	1
1	1	0	0	1	1	0	0
1	1	0	1	1	1	0	1
1	1	1	0	1	1	1	0
1	1	1	1	1	1	1	1

## HS527 Absolute Maximum Rating: (Compatible:EV1527,RT1527,FP1527)

Symbol	Parameter	Conditions	Rating	Unit
Vcc	Supply voltage		-0.3 ~ 13	V
VI	Input voltage		-0.3 ~ Vcc+0.3	V
Vo	Output voltage		-0.3 ~ Vcc+0.3	V
Tst	Storage temp		-40 ~ 125	°C
Top	Operating temp		-20 ~ 70	°C
Pdis	Max.power dissipation	Vcc = 12V	300	mW

Silvan Chip Electronics Tech.Co.,Ltd.

Address: Fl.16 FuChang Building,Binhe Rd,Shenzhen,China

Phone: 86-0755-88291843 88304213 Fax : 86-0755-88290509

Email: [jj@sc-tech.cn](mailto:jj@sc-tech.cn)

Http:// [www.sc-tech.cn](http://www.sc-tech.cn)

# HS527 OTP Encoder

## HS527 Rosc& data cycle:(Compatible:EV1527,RT1527,FP1527)

Rosc& TD:		12V	11V	10V	9V	8V	7V	6V	5V	4V
300K		1.34ms	1.37ms	1.41ms	1.45ms	1.5ms	1.57ms	1.66ms	1.79ms	1.99ms
330K		1.48ms	1.51ms	1.55ms	1.59ms	1.64ms	1.71ms	1.81ms	1.94ms	2.19ms
360K		1.71ms	1.75ms	1.79ms	1.84ms	1.91ms	1.99ms	2.11ms	2.27ms	2.53ms
390K		1.82ms	1.86ms	1.91ms	1.96ms	2.03ms	2.11ms	2.24ms	2.401ms	2.69ms
430K		2.035ms	2.085ms	2.135ms	2.195ms	2.265ms	2.365ms	2.505ms	2.705ms	3.01ms

## HS527 Schematic diagram:(Compatible:EV1527,RT1527,FP1527)

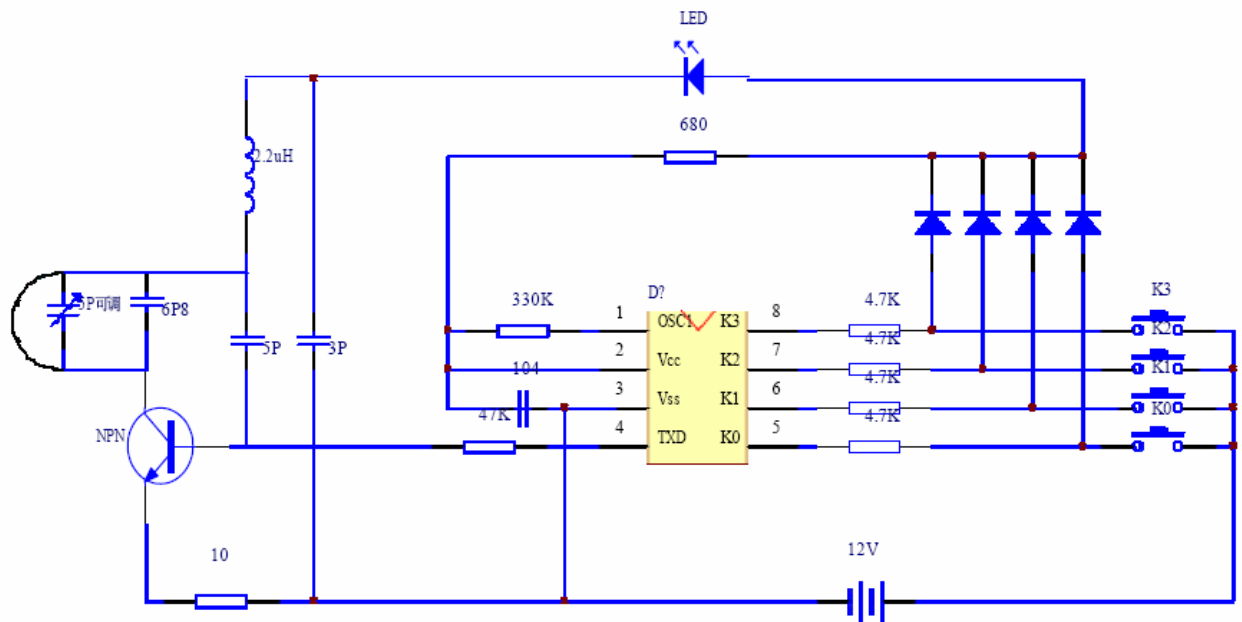

**Silvan Chip Electronics Tech.Co.,Ltd.**

**Address:** Fl.16 FuChang Building,Binhe Rd,Shenzhen,China

**Phone:** 86-0755-88291843 88304213 **Fax :** 86-0755-88290509

**Email:** [jj@sc-tech.cn](mailto:jj@sc-tech.cn)

**Http://** [www.sc-tech.cn](http://www.sc-tech.cn)